

## MeterMatch<sup>TM</sup>

### Overview

The MeterMatch<sup>TM</sup> Model MM-02 by TechnoVersions LLC is for making analog gauges more accurate, or to allow you to mix and match different gauges and senders. It can be used with many gauges that have resistive senders - such as common fuel, oil-pressure and temperature gauges. In addition, it allows you to have low and/or high set-points that will trigger a bright, flashing LED indicator to alert if the gauge exceeds normal values.



*Note: If you are having trouble reading the small print of this instruction manual, go to the [TechnoVersions.com](http://TechnoVersions.com) website and open the on-line copy that you can print out full size.*

### Theory of Operation

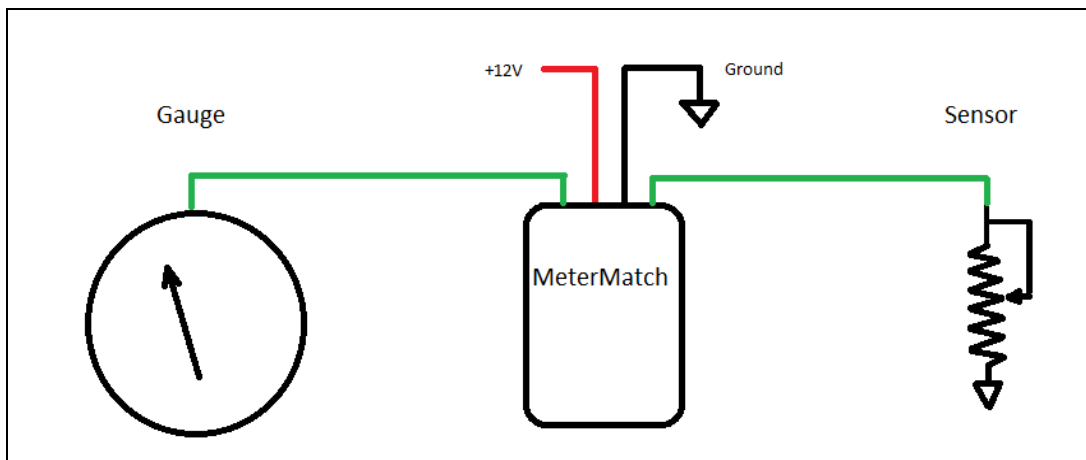

MeterMatch is wired between your sender (sensor) and your gauge. It reads the resistance of the sender, then based on the calibration values, controls the current through the gauge to drive it to the desired reading. It treats the input and output entirely separately, so it doesn't care if the input to the gauge is scaled differently than the sender, or even if the sender signal is reversed - it can correct for that. In the graphic above, prior to installation the green lines would be connected together. MeterMatch interrupts that signal to process it and make corrections.

To calibrate MeterMatch, you first set the sender to a known value. For example, fill your fuel tank. Set the MeterMatch to program mode, then with **Up** and **Dn** buttons, make your gauge read what you want for that sender value. When you are happy with that, press the **Save** button, and the value is

remembered in the MeterMatch. Do the same process with the sender reading a value near the other end of its range, and you are done. MeterMatch interpolates from these values to make the gauge read proportionately at values above, below, and between the calibration values. If you know the resistance of your sender, you can also calibrate to common values, even without the sender being at that specific resistance. The calibration points are typically near the ends of the gauge limits, but can be anywhere – for example you can have your only calibration points at 25% and 75%, and it will still work, but won't be quite as accurate outside of those points.

The basic process of having the gauge read properly from calibration points near each end of the range is fine for most applications, but you can be more sophisticated if you wish. For example, what if your fuel tank is large at the bottom, and small at the top? In this case, it won't read properly throughout the range. MeterMatch provides two additional calibration points between the endpoints. So, in this case, you could have an additional calibration point where the tank changes size. Another use for these points would be if your tank is cylindrical (like a truck fuel tank) so the gauge is inaccurate at both sides of center. Here, you can add additional calibration points (for example at 30% and 70%) and the accuracy is drastically improved

The calibration data inside MeterMatch is stored internally in non-volatile memory that is maintained, even when power is removed.

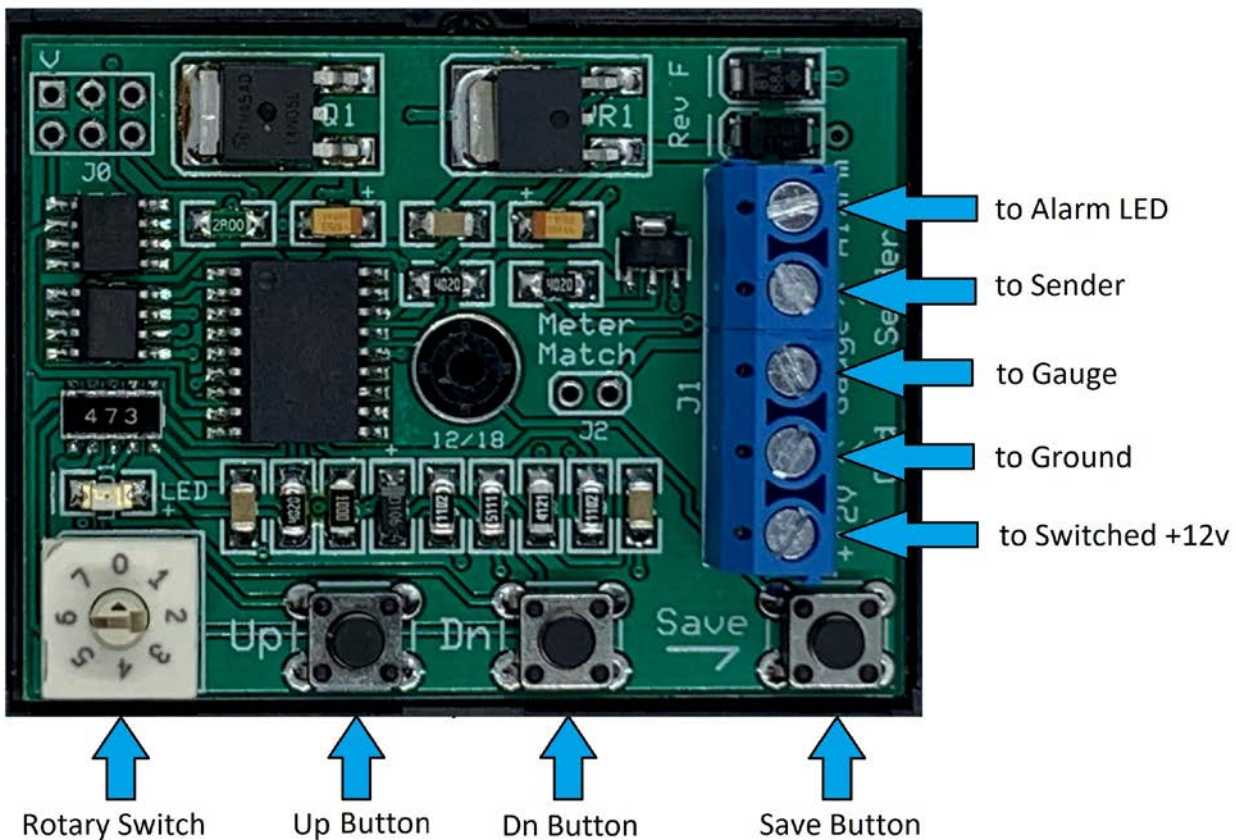

## Installation

To install and calibrate your MeterMatch, you will need to expose the circuit by removing the small #1 Phillips-head screw in the bottom center of the enclosure. Take care that the circuit board doesn't touch any metal which could short things out, and when finally installed, make sure it is in a dry spot that doesn't get overly hot.

It is wired by connecting to a screw-terminal strip inside. You will need a small straight-blade screwdriver (tip width less than .15"). It accommodates wire sizes from #14 AWG to #22 AWG. Wires in the mid area of this range, for example #18 AWG, work well.

MeterMatch only requires four wires with signals that are usually available near the back of the gauge. The signals are connected to the terminal strip positions:

Pin 5	Alarm signal (typically not used)
Pin 4	From Sender (input to MeterMatch)
Pin 3	To gauge (output from MeterMatch)
Pin 2	Ground – ensure that it is well grounded
Pin 1	+12V (switched by ignition) – requires only a few mA



## Calibration

Once wired, it is necessary to calibrate your MeterMatch to tailor it to your sender and gauge. As shipped, default values are in place for switch positions 1 and 4.

The rotary switch  positions are used as follows:

<b>0</b>	<b>Normal operation after calibration</b>
<b>1</b>	<b>High calibration point</b>
2	Mid-high calibration point (typically not used)
3	Mid-low calibration point (typically not used)
<b>4</b>	<b>Low calibration point</b>
5	Alarm high calibration point (typically not used)
6	Alarm low calibration point (typically not used)

In addition to the terminal strip and rotary switch, you will find three push-buttons:

	Moves the meter needle one direction
	Moves the meter needle the other direction
	Stores the calibration point presently selected

### **Standard calibration process (sender resistance not known):**

1. Set your sender to a point near one end of the value being measured (we'll start at the top in this example, but order is unimportant).
2. Set the rotary switch  to position "1" (High Calibration Point). The LED in MeterMatch will light up.
3. Use the /Dn buttons to make your gauge read the appropriate setting for the present sender output. Depending on the gauge, the buttons may work backwards, but don't worry about that - just make the gauge read the desired value. Some meters are well-dampened so this process can take a little time. It doesn't hurt to tap lightly on the gauge too. If you press and hold an /Dn button, the gauge signal from MeterMatch will continually move. It takes about fifteen seconds for the MeterMatch to move over its entire range with one of the buttons held down continuously.
4. Press the  Save button to save this calibration point. The MeterMatch reads the sender, then saves that value, along with the gauge signal, into its internal memory. The LED on MeterMatch will go out momentarily to indicate that the values are being saved, then turn back on.

*Note: Calibration doesn't need to be done at the extreme high and low sensor points, but most accuracy is achieved when near the limits of the readings.*

Repeat these steps but with the sender set to a position for the other end of measurement, the rotary switch  to "4" (Low Calibration Point), and then use the /Dn buttons until gauge is reading appropriately, then press  Save again.

Finally, set the MeterMatch rotary switch  back to "0" (Normal Operation), put the cover back on, and installation is complete.

You can go back and reset any point using the same process, it will simply over-write the data for that point stored previously. If you would like to erase a point (for example a point or limit you don't want to use any more): with no power applied, set the rotary switch  to the position reflecting the point you want to erase, hold down the  Save button, then turn power back on. The LED will blink.

### **Alternate calibration process (sender resistance known):**

If you know the resistance of your sender, you can use that to help do calibration in place of making the actual sender be in different positions during the calibration. You will need to know the sender range (end-points) in Ohms. For example, the sender might be 240  $\Omega$  (Ohms) when the reading is low, and 33  $\Omega$  when the reading is high. If you have this data, there are two ways that you can use it for calibration:

**Method 1:** Connect a resistor (available at places such as Radio Shack) of the desired value on the MeterMatch sender input pin (pin 4) to ground, then perform calibration at that point just as with the standard calibration process previously shown.

**Method 2:** You can have MeterMatch calibrate to some internally stored resistance values. To use these, do the following:

1. Power up MeterMatch
2. Set the rotary switch  $\Theta$  to zero (normal operation)
3. Press and hold the **Save** button. The LED will illuminate.
4. While the **Save** button is being held down, press the **Up** button, the number of times shown in this table. Each time you press the **Up** button the LED will blink the number of times that it has been pressed. For example, after you have pressed it twice, it will blink twice. You can start over at any time by releasing the **Save** button.

Number of "Up" Button Pushes	Sender Resistance Simulated (Ohms)
1	0
2	10
3	33
4	73
5	90
6	180
7	240

5. Release the **Save** button, then use the standard calibration procedure: rotary switch  $\Theta$  to which point you are setting, **Up/Dn** buttons to make gauge read the desired setting, then **Save**. When the **Save** button is pressed (and the rotary switch  $\Theta$  is not set to 0), MeterMatch will use the resistance value you just entered, and then reset itself to back normal operation.





### Calibration Checking and Enhancement

Feel free to use a combination of these calibration methods. For example, you might initially calibrate to the published resistance values of your sender, then when the opportunity comes to improve accuracy, recalibrate a point. Using the fuel gauge, for example, recalibrate the end-point when you run out of gas, or fill up the tank. Whenever you return to a position of the rotary dial, you can overwrite the data that was previously programmed.



### Resetting Data in MeterMatch

If you would like to reset the MeterMatch back to factory defaults: (1) remove power from the unit, (2) set the rotary switch  $\Theta$  to zero, (3) press and hold the **Save** button, and finally (4) reapply power to the unit and wait until the power-up LED blinks, indicating that power-up is complete. This presets the low and high values (switch positions 1 and 4) to values typical for after-market gauges, and sets other internal settings to defaults.

## Voltage Correction



Most gauges are connected to a voltage regulator in the instrument wiring so that they get a constant voltage whether the engine is running or not. However, if this is not the case, when you calibrate your gauge at one voltage (for example, engine not running, battery at +12.5V), then start the vehicle and the voltage rises (for example to +13.8V), the gauge reading might change significantly. If you run into this, MeterMatch has an automatic voltage correction feature that corrects the reading for different voltages. To enable this feature: (1) remove power from the MeterMatch, (2) set the rotary switch  to position "0" (normal operating), then (3) press and hold the  button while applying power to the MeterMatch. Hold it until the LED blinks after power is applied. MeterMatch will remember this setting in future use. If you wish to remove the voltage correction feature, repeat the same process, but hold the  button rather than the  button. Note that if you change this setting, the gauge may need to be recalibrated with the new setting.

## Reading Averaging

In the default mode, the MeterMatch averages readings to make the needle move more slowly. This is not necessary on older, slower-responding gauges, but can come into play with more modern gauges that have less internal dampening. This feature can be turned on and off with a power-up sequence: (1) remove power from the unit, (2) set the rotary switch  to zero, (3) press and hold the  button to turn on averaging, and finally (4) reapply power to the unit and wait until the power-up LED blinks, indicating that power-up is complete. Turning off sample averaging is the same, but instead pressing the  button.

## Early Ford/Mopar Gauges with Mechanical Regulators

If you are controlling a gauge that is powered by a mechanical voltage regulator in the dash panel (such as early Ford and Chrysler products), you can reset the MeterMatch to near-correct values by performing the reset operation just as above, except setting the rotary switch  to seven rather than zero during the power-up. This will also turn on Voltage Correction which is necessary when using a vibrator-type instrument voltage regulator.

If you use this electronically regulated source of power, or have an electronic regulator in your vehicle, Voltage Correction should be turned off. You can set to near-correct values for gauges with electronic regulators by resetting the MeterMatch in this fashion: (1) remove power from the unit, (2) set the rotary switch  to seven, (3) press and hold the  and  buttons, and finally (4) reapply power to the unit and wait until the power-up LED blinks, indicating that power-up is complete.

*Note:* the MeterMatch MM-02 is capable of powering one gauge with its internal 5V-regulated voltage source – contact TechnoVersions for details.

## Installing/Programming an Alarm Indicator

An LED Alarm Indicator can be mounted near the gauge being controlled. When activated, the MeterMatch produces a flashing on/off signal to the LED to alert you to check the gauge. The circuit will generate approximately 25mA across the LED. It is an open-collector output with 400  $\Omega$  series resistance.

LEDs typically have a longer lead for the anode (+), and shorter lead on the cathode (-) terminal. Connect the LED cathode to Pin 5 of the terminal strip, and the LED anode to +12v switched, such as Pin 1 of the MeterMatch.

It won't hurt anything if you accidentally reverse the alarm wires, but the LED won't light.

Pin 5 terminal strip	LED negative (cathode)
+12V switched	LED positive (anode)

You can program the upper and lower alarm points with rotary switch  positions 5 and 6 respectively. Set the rotary switch , use the /Dn buttons to set the desired gauge reading at the set-point, then press . MeterMatch doesn't care what value the sender is at while programming the alarm points - it is only interested in what you make the gauge read with the /Dn buttons. As a result, ensure that you have calibrated your gauge accurately (rotary switch  positions 1-4), or your alarm will not be accurate either.

These points can also be erased using the same procedure as normal calibration points. Depending on how your gauge works, you may find that the low and high alarm set-points are reversed in operation from what you expect. If that's the case, simply reverse the calibration (use high for low and vice-versa).

If you have more than one MeterMatch installed, you can logic "or" the LED signals so that if any of the alarm signals become true, they will set off a single LED. Simply connect the LED negative (cathode) in parallel to each MeterMatch (Pin 5).

## Return Policy

If a MeterMatch unit does not work properly in your application, and is not damaged, TechnoVersions will allow return for full refund of purchase cost, exclusive of shipping charges. Claim for such must occur within 30 days of product shipment from TechnoVersions. Ship the unit back to TechnoVersions along with a description of the problem and proof of purchase. TechnoVersions will remit the refund via US Mail or PayPal (at TechnoVersions discretion) within 10 working days of product receipt.

## Limited Warranty, Terms and Conditions

TechnoVersions LLC provides a limited warranty for MeterMatch. If a unit should fail within 180 days from time of shipment from TechnoVersions, it can be returned for repair or replacement at TechnoVersions discretion. Products subject to abuse (as determined by TechnoVersions) are excluded from this limited warranty. TechnoVersions LLC makes no other claims as to suitability and excludes any liability for direct, indirect or consequential damages. Exclusive remedy is limited to product replacement or repair. Cost of shipping the returned product to TechnoVersions is at the customer's expense, but the replacement/repaired MeterMatch will be shipped to the customer via USPS or UPS ground at TechnoVersions expense, except for shipments out of the US, in which case TechnoVersions shipping cost is limited to the cost of domestic shipments. When returning MeterMatch to TechnoVersions, include a description of the fault to help facilitate repair. Risk of damage/loss during shipping becomes the customer responsibility once the product is delivered to a common carrier by TechnoVersions

<b>MeterMatch™ Specifications</b>	
Size	1.85"x2.4"x0.93"
Weight	1.2 Oz
Connections	1x5 screw terminal strip accepting #14-#22 AWG wires
Sender Input	Ohmmeter reading of sender input to ground
	Max current through sender 50mA/5Vdc Max voltage at sender input: 5Vdc
	Resolution approximately 1 $\Omega$ for readings less than 1 k $\Omega$ .
	Range 0-3,000 $\Omega$
Gauge output	Constant-current sink
	Full output range resolution better than 1%, actual resolution depends upon working range of gauge
Input/Output Translation	Meter output current based on linear interpolation of sender resistance calibration points.
	Four calibration points provided, minimum of two necessary for operation.
Alarm LED Output	Programmed flashing
	Open collector output with approximately 400 $\Omega$ series resistance between output and ground
Controls	Up, Down, Save buttons
	8-Position rotary switch